

Capacity.

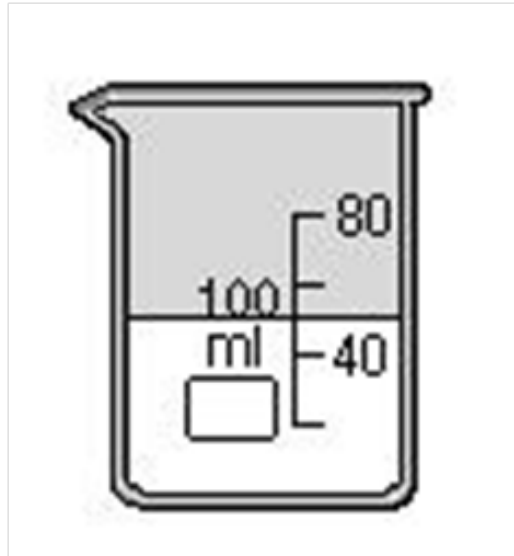

EMPTY



HALF FULL



FULL



MAKE GIFS AT GIFSOU.P.COM

Which bucket is full, half full and empty?



Which bottle is full, half full and empty?

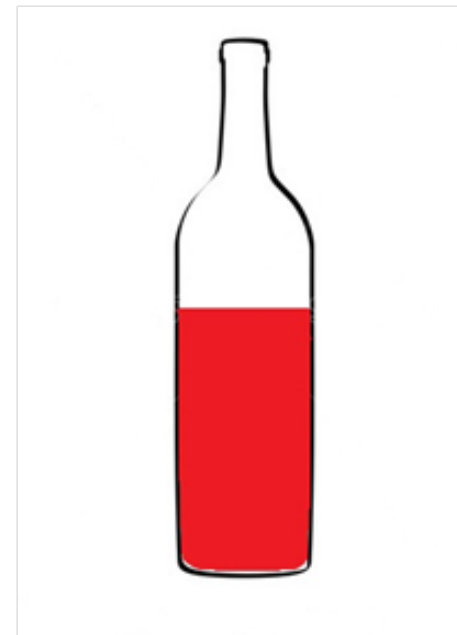
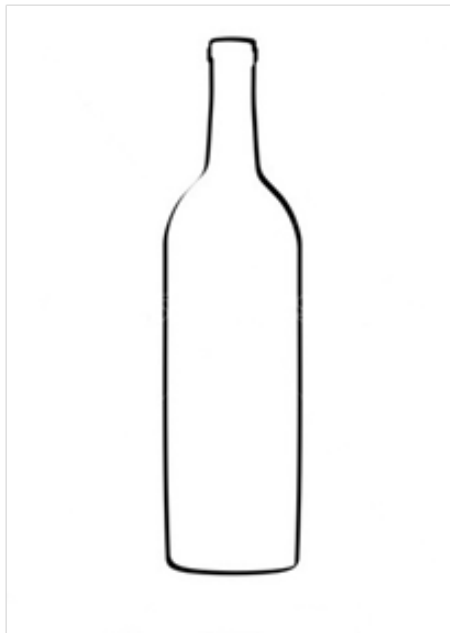

Which vase is full, half full and empty?

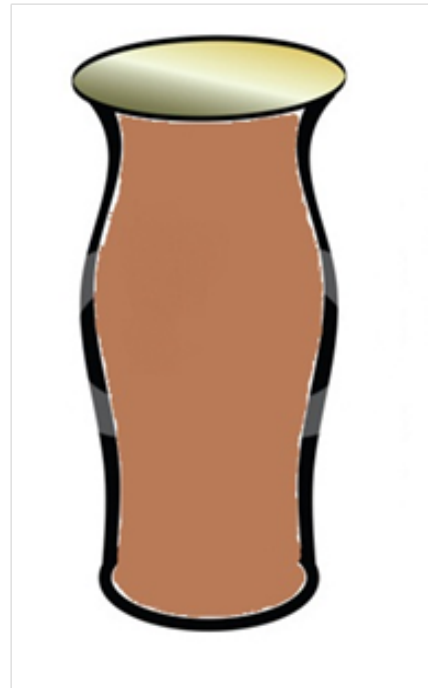
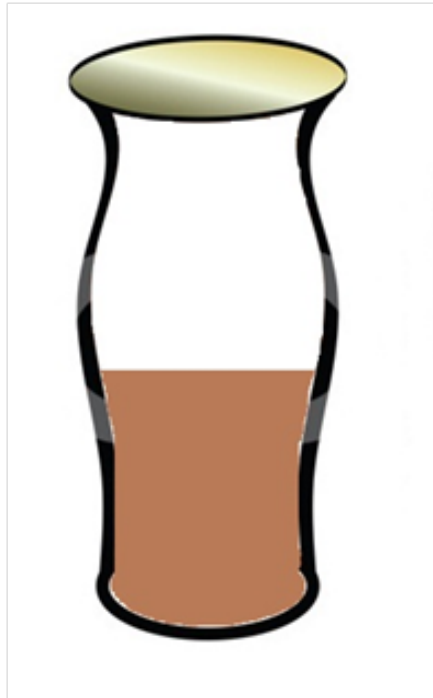

Put the full containers in the box.

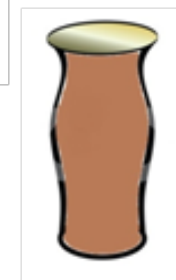

Put the half full containers in the box.

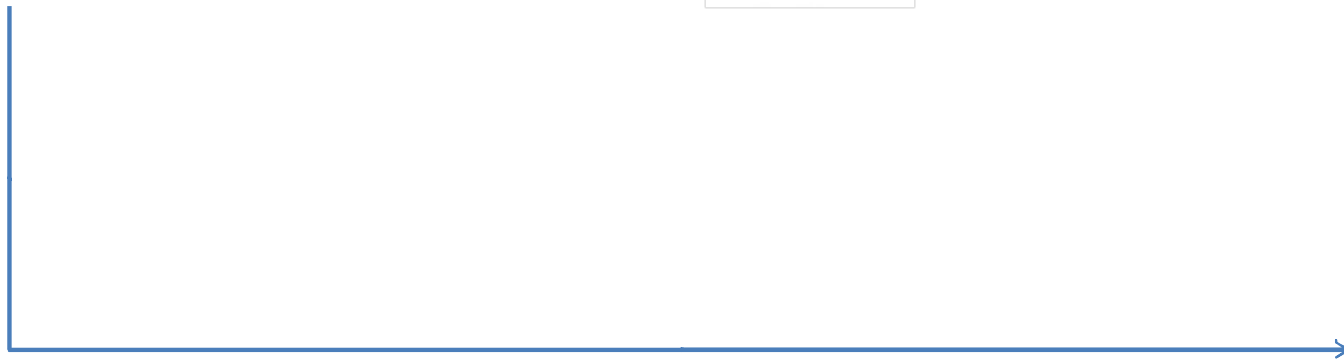
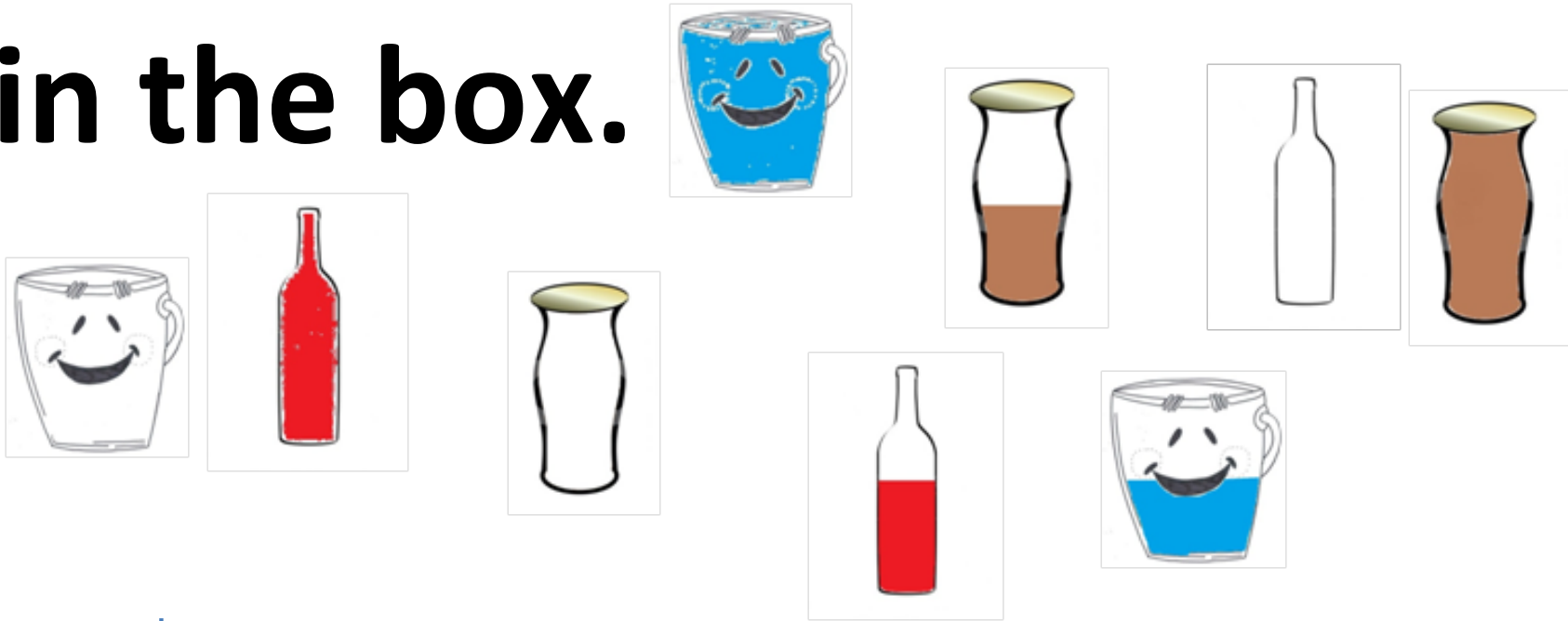

Put the empty containers in the box.



